

approx 81.6kg (180lb)

- PENDANTS: sixty-one
- CANOPY: white powder-coated round canopy 707 (27.8") diameter
- LAMPING: 20w xenon or 1.8w LED
- LENGTH OF COAX: 3000 (10') standard / 30500 (100') maximum
- INSTALLATION: jack-connected (lengths set during production)
- MATERIALS: blown glass, braided metal coaxial cable, electrical components, powder coated steel hardware and white-powder coated steel canopy
- WEIGHT: approximately 81.6kg (180lb)
- TRANSFORMERS: integral

DESCRIPTION

28.61 is a cluster of sixty one 28 pendants hung from a round canopy. The pendants hang in shape of a hexagonal bouquet, bundled together by an adjustable ring, which changes the curvature of the piece and its proportional reading.

28 is an exploration of specificity in manufacturing. Instead of designing form itself, here the intent was to design a system of making that yields form. Individual 28 pendants result from a complex glass blowing technique whereby air pressure is intermittently introduced into and then removed from a glass matrix which is intermittently heated and then rapidly cooled. The result is a distorted spherical shape with a composed collection of imploded inner shapes, one of which acts as a shade for a low voltage (12V, 20W) xenon light source.

28 pendants are designed to cluster in hexagonal shapes which nestle into each other to create patterns as dictated by the needs of the interior. They may also be clustered or composed in an ambient manner similar to their distant cousins the 14's.

Standard 28's are made with clear glass exterior spheres and milk white interior lamp holder cavities. 28's are possible with infinite versatility in colour compositions, sizes and shapes.

NOTES

- + Preset pedant lengths may have a variance of ±50mm (2")
- + Purchase replacement lamps online at www.bocci.ca/lamps
- + Unless otherwise noted when ordering, all chandeliers will be outfitted to be xenon compatible.
- + Note: As an alternative to a built-in transformer, Bocci recommends mounting transformers remotely in an easily accessible and hidden location for ease of long-term maintenance.

US patent # D687,740 Worldwide patents issued and pending.
Made in Vancouver, Canada

BOCCI Vancouver
sales@bocci.ca
www.bocci.ca

BOCCI Berlin
europe@bocci.ca
www.bocci.ca



CLUSTER

28.61

Design by Omer Arbel
PRODUCT SPECIFICATION

707 (27.8")

577 (18.5")

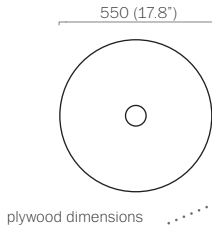

plywood dimensions

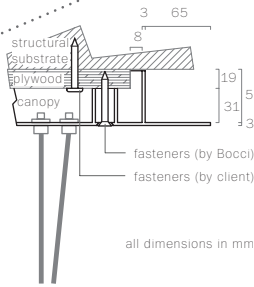

all dimensions in mm

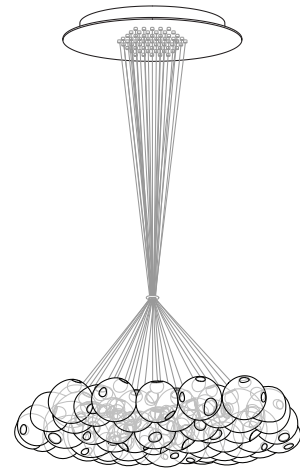
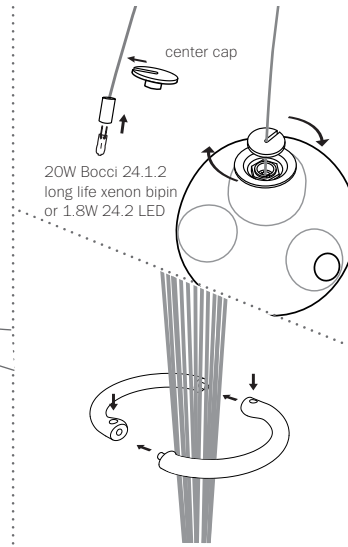
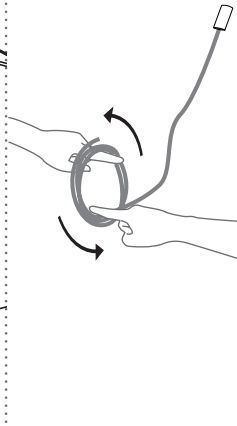
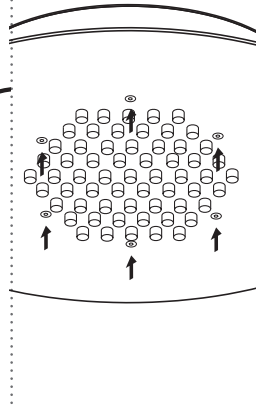
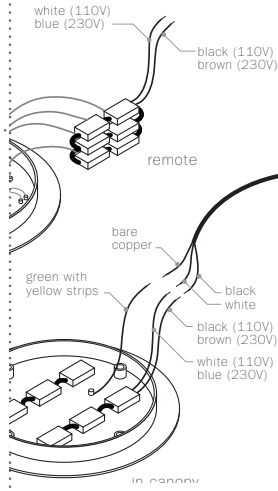

1

Measure and mark out the chandelier canopy position on the ceiling.

2

Note: The client is responsible for providing a robust 3/4" (19mm) plywood backing or wood blocking to securely anchor to the structural substrate.

Connections from the plywood to the structural substrate are the client's responsibility. Measure the plywood so that it fits within the canopy side walls (refer to detail above).

Anchor the plywood backing to the structural ceiling substrate.

3

Connect transformers inside the canopy to line voltage, ensuring to match black wire to black wire and white to white. For the ground connection, connect the green wire with yellow stripe to the bare copper wire or green wire in the junction box.

Note: As an option, Bocci recommends mounting transformers remotely in a close by, accessible and hidden location for ease of long term maintenance. Installation to be done by certified personnel to ensure code compliance.

4

Anchor canopy into the plywood backing using the fasteners provided.

5

Very carefully uncoil the braided coaxial cable in a spool like manner. Insert your index fingers into opposite sides of the roll then rotate your fingers around each other to unroll the coaxial cable.

Use patience: allow the cable to uncoil completely to avoid kinks.

6

Each pendant terminates in a "headphone jack" type connector, which plugs into a receiving receptacle in the canopy. Plug in each pendant and turn the threaded sheathing into place by hand ensuring that it is adequately tightened. Tools are not required.

Bocci 24.1.2 long life bipin xenon lamps are included. Plug the lamp into the socket. Do not touch the lamp with your bare hands.

Remove the center cap from 28 pendant. Install 28 pendant by sliding the center cap onto the coaxial cable, gently insert the lamp into the pedant, then tighten the center cap connection by hand. Do not over tighten. Remove the protective film from the center cap after assembly.

Note: when using a dimmer for xenon use only low voltage electronic dimmer.

Prior to installing the ring around the coaxial cables, ensure that the pendants are composed in their intended hexagonal formation.

Gather the coaxial cables then install the ring with setscrews provided. Note: setscrews face up.

7

Adjust stainless steel ring to desired height.

Clean fingerprints from glass surfaces.

Turn fixture on.

* Purchase online for replacement lamps at www.bocci.ca/lamps

For additional assistance, please contact Bocci:

BOCCI Vancouver
info@bocci.ca
www.bocci.ca

BOCCI Berlin
europe@bocci.ca
www.bocci.ca

US patent # D687.740
Worldwide patents issued and pending.

Made in Vancouver, Canada

Approved to UL standards by CSA



CLUSTER

28.61

Design by Omer Arbel
INSTALLATION INSTRUCTIONS