

# COMPILE SHELVING SYSTEM

FURNITURE / LIGHTING / ACCESSORIES

# PRODUCT FACT SHEET

**CECILIE MANZ ON THE DESIGN** "Storage is important because it is so universal: everybody needs good solutions. The inspiration for the assignment was indeed the everyday storage situation. The design, with its logical construction, parallels to a certain degree an unpretentious Scandinavian lifestyle - one shelf represents one building unit while the length of the tube defines the shelf height. In this simple way one can assemble practical formations that fit individual needs - COMPILE should reflect and accommodate to the life it is a part of."

## PROCESS

Shelves are made from laser cut steel sheets, bent to form, and then coated with high quality powder coating. This coating gives the shelves a matt, abrasion-resistant and fingerprint-insensitive surface.

## DESIGNED BY / YEAR OF DESIGN

Cecilie Manz / 2016

## TYPE

Customizable shelving system

## DESCRIPTION

A contemporary take on the classic shelving system. COMPILE consists of a shelf and three heights of dividing tubes. Arrange the shelves and tubes as you please or order from the prearranged configurations.

## ENVIRONMENT

Indoor

## DIMENSIONS (CM)

H: 14 / D: 42 / W: 120  
(Storage surface: W: 115 / D: 40)  
Large dividers: H: 39  
Medium dividers: H: 28,5  
Small dividers: H: 18  
Top: H: 11  
Feet: 11,6

## MATERIAL

Powder coated steel

## EXTRA

COMPILE systems should always be mounted to a wall, using wall brackets.

A COMPILE shelving system can hold up to 300 kg.

COMPILE shelving systems can be built as tall as wanted, as long as they are mounted to a wall using brackets. Muuto recommends not building COMPILE systems higher than 2,25 meters.

## TESTS & CERTIFICATION

The Danish Technological Institute - EN 16139:2013 L1. Tested to withstand level 2: Extreme use. Tested to with-stand use in areas where the furniture is occasionally subject to extremely high loads. i.e. Nightclubs, railway stations, transport terminals.

## CLEANING INSTRUCTIONS

Remove dust from shelves with a soft cloth or remove abrasive dust particles.

## ABOUT THE DESIGNER

Cecilie Manz is one of Denmark's most promising young designers. Her work within furniture, glass, lighting and ceramics has achieved international success and is sold and exhibited all over the world.



Shelf

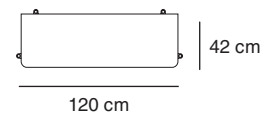

Dividers

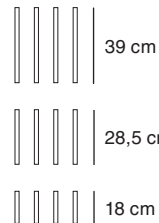

Essentials

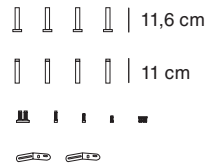

# COMPILE SHELVING SYSTEM

FURNITURE / LIGHTING / ACCESSORIES

# PRODUCT FACT SHEET

**CECILIE MANZ ON THE DESIGN** "Storage is important because it is so universal: everybody needs good solutions. The inspiration for the assignment was indeed the everyday storage situation. The design, with its logical construction, parallels to a certain degree an unpretentious Scandinavian lifestyle - one shelf represents one building unit while the length of the tube defines the shelf height. In this simple way one can assemble practical formations that fit individual needs - COMPILE should reflect and accommodate to the life it is a part of."

Config. 1

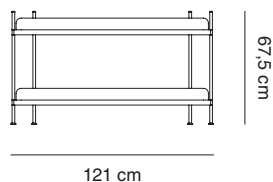

Config. 5

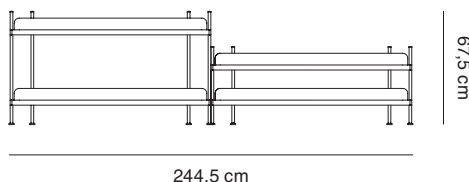

Config. 2

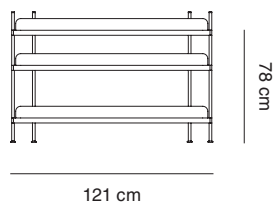

Config. 6

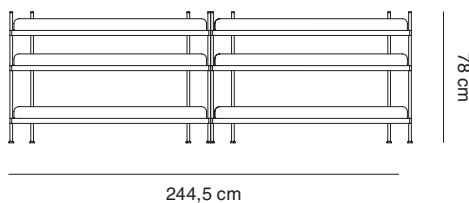

Config. 3

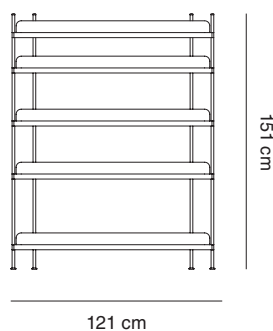

Config. 7

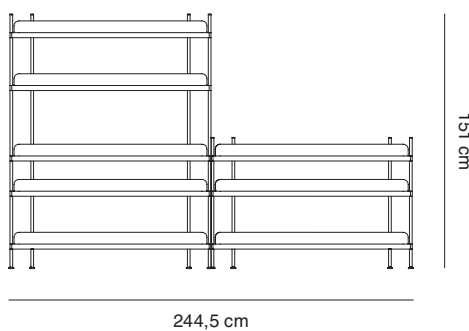

Config. 4

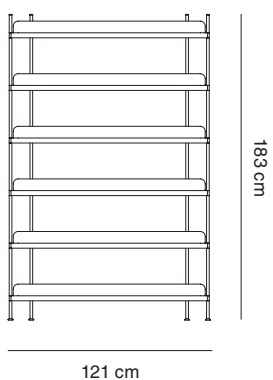

Config. 8

