

# *punt*

ART, CRAFT & DESIGN



## MITIS

TECHNICAL INFORMATION SHEET

# MITIS - MITIX

BY MARIO RUIZ, 2012

*punt*



---

## PRODUCT TYPE

Table

Collection of tables with a solid appearance and exquisite details both in the tabletop and in its slotted trestle legs.

---

## TIPOLOGÍA DE PRODUCTO

Mesa alta

Colección de mesas de aspecto sólido y detalles exquisitos tanto en el tablero como en sus patas ranuradas de tipo caballete.

## DETAILS. DETALLES



# MITIS - MITIX

BY MARIO RUIZ, 2012

**punt**

MITIS H75 cm - 29.5 in

## MTS102

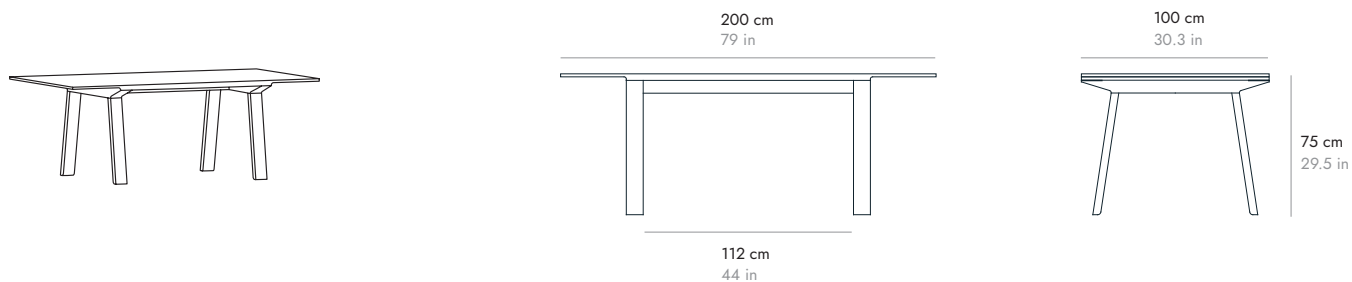

## MTS104

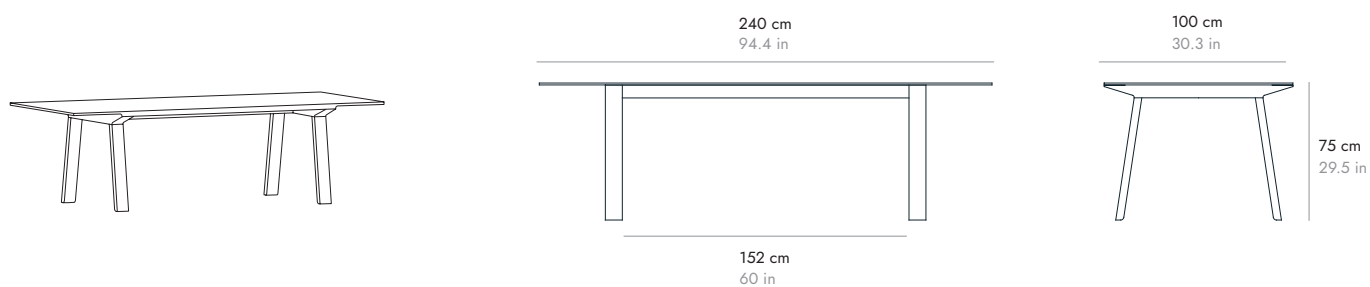

## MTS107

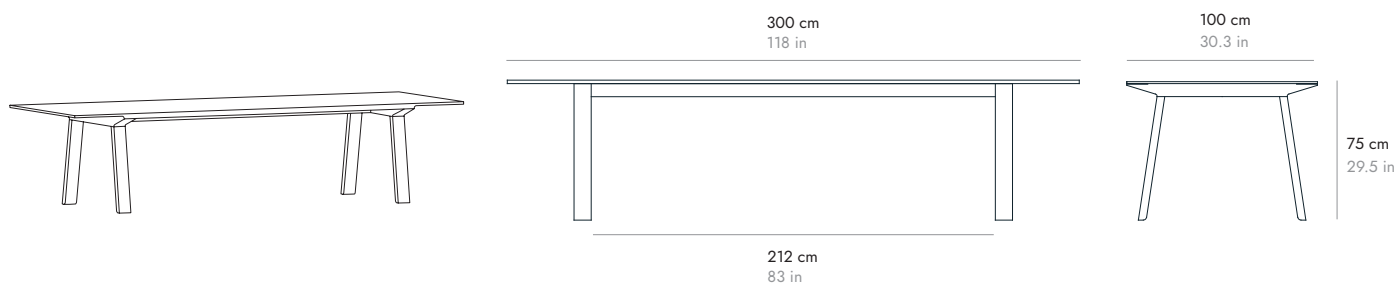

# MITIS - MITIX

BY MARIO RUIZ, 2012

*punt*

MITIS H110 cm - 43.3 in

MTS402

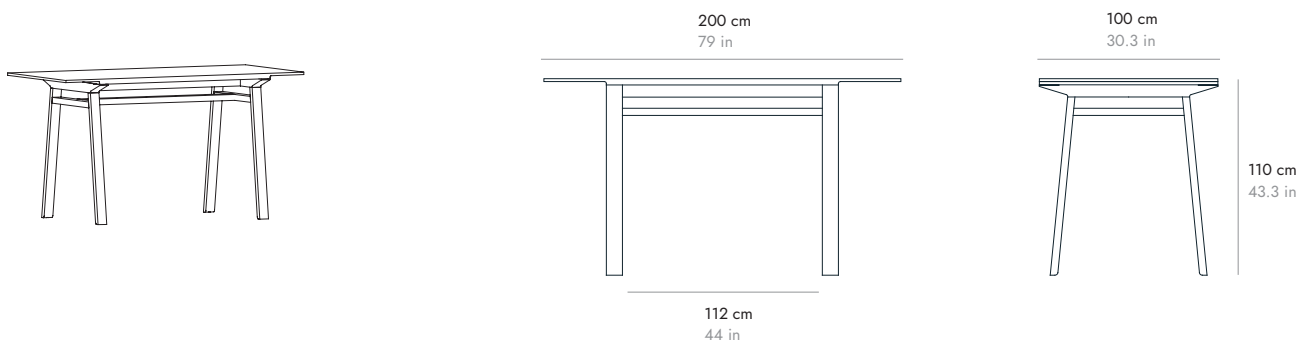

MTS404

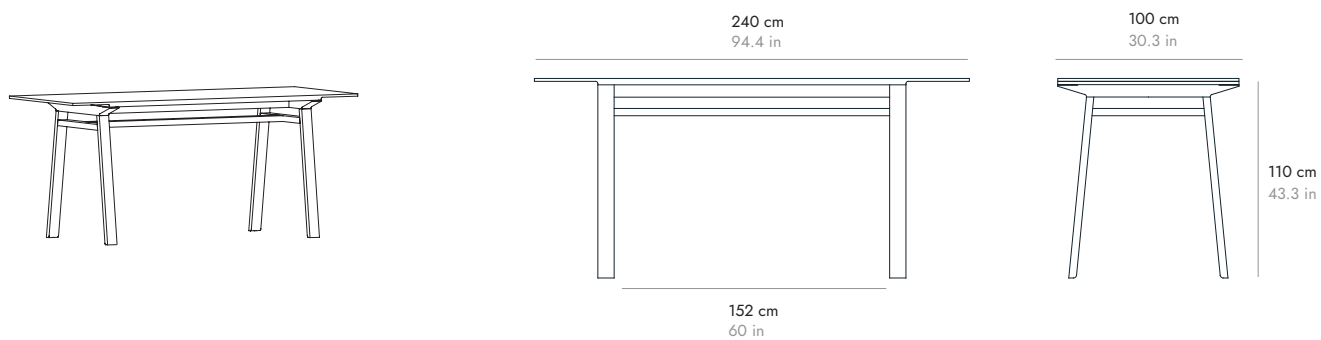

MTS407

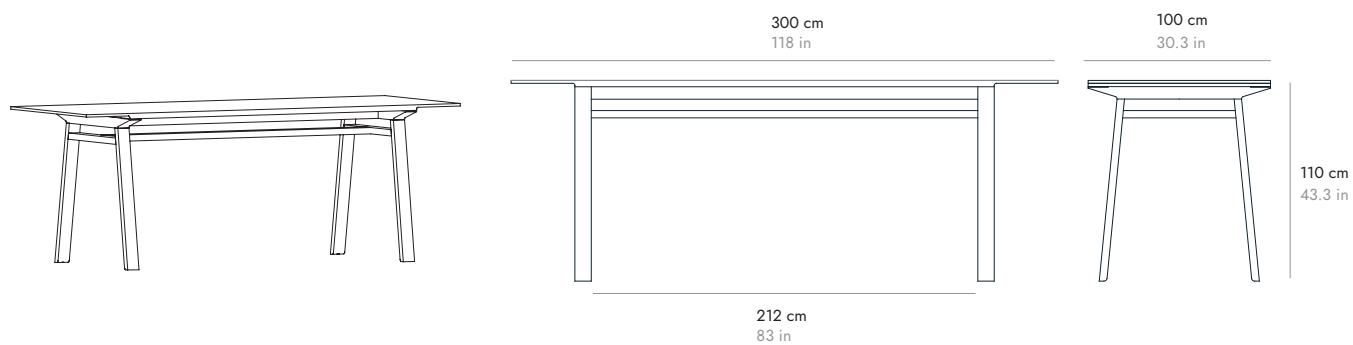

# MITIS - MITIX

BY MARIO RUIZ, 2012

*punt*

MITIX H75 cm - 29.5 in

## MTX101



180 cm  
70.8 in



162 cm  
63.8 in

100 cm  
30.3 in

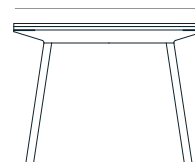

75 cm  
29.5 in

## MTX102



200 cm  
78.7 in



182 cm  
71.7 in

100 cm  
30.3 in

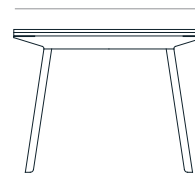

75 cm  
29.5 in

## MTX103



240 cm  
94.4 in



222 cm  
87.5 in

100 cm  
30.3 in

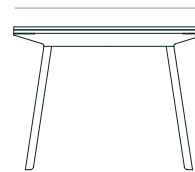

75 cm  
29.5 in

# MITIS - MITIX

BY MARIO RUIZ, 2012

**punt**

## SPECIAL DIMENSIONS. MEDIDAS ESPECIALES

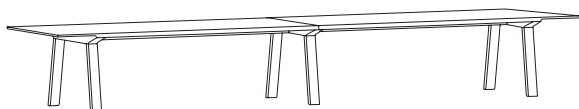

Mitis and Mitix tables are available in special sizes upon request. Please contact our sales department for a quotation.

Las mesas Mitis y Mitix está disponible en medidas especiales bajo pedido. Por favor consulte con el departamento comercial para su cotización.

## COMPOSITIONS. COMPOSICIONES

**MITIS104 + HUG**

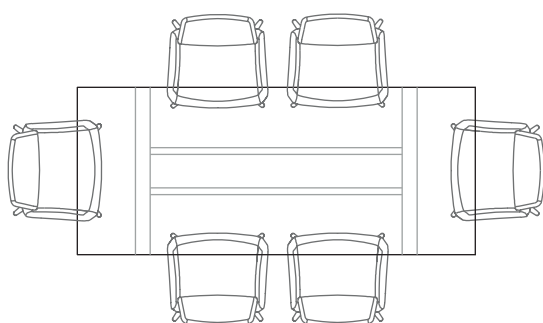

240 cm  
94.4 in

**MITIX103 + HUG**

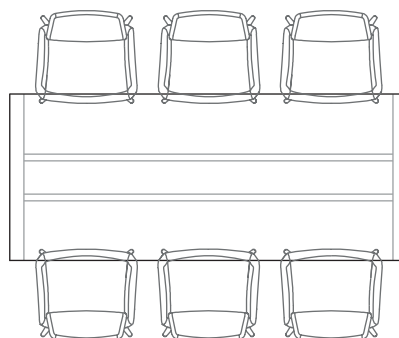

240 cm  
94.4 in

## ACCESORIES MITIS. ACCESORIOS MITIS



**ACC069**

### MITIS CABLE GROMMET

Cable grommet recessed in the leg of the Mitis table, which allows cables to be placed inside its section. Maximum cable diameter 7 mm - 0.27 in.

### PASACABLES MITIS

Pasacables empotrado en la pata de la mesa Mitis, que permite colocar cables dentro de su sección. Diámetro máximo del cable 7 mm - 0.27 in.

## ACCESSORIES. ACCESORIOS

ACC052



Aluminum grommet to be placed on the top face of the envelope, in order to allow the passage of the cables of electronic elements and to hide them under the table.

Pasacables de aluminio para situar en la cara superior del sobre, con el objetivo de permitir el paso de los cables de elementos electrónicos y que queden ocultos bajo la mesa.

ACC036

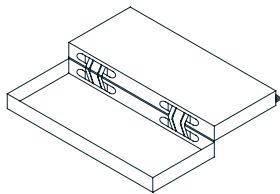

Hinged grommet embedded in the finish of the top.

Pasacables con bisagra incrustado en el acabado de la encimera.

ACC051

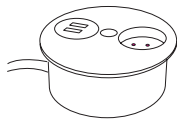

1 power sockets + 2 USB ports.

1 enchufe + 2 puertos USB.

ACC047

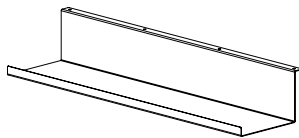

Trag. The duct is fixed on the underside of the table top, so the cables can be threaded through it.

Canaleta. El conducto se fija en la parte inferior del tablero de la mesa, de modo que los cables pueden pasarse a través de él.

ACC064

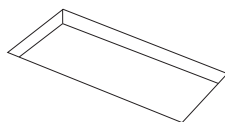

Rectangular machined hole made to measure.

Hueco rectangular mecanizado a medida.

ACC066



Circular machined hole made to measure.

Hueco circular mecanizado a medida.

ACC133

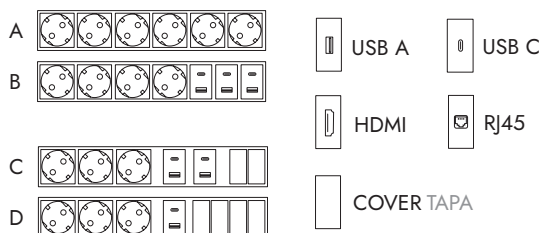

Electrifications A and B have only charging elements (plugs and USB), while in electrifications C and D the free spaces can be completed with multimedia elements such as RJ45, HDMI, USB.

Las electrificaciones A y B disponen únicamente de elementos de carga (enchufes y USB), mientras que en las electrificaciones C y D se pueden completar los huecos libres con los elementos multimedia como RJ45, HDMI, USB.

# MITIS - MITIX

BY MARIO RUIZ, 2012

**punt**

## MATERIALS

### Wood.

Top in MDF E1 board (low formaldehyde content) in oak or natural walnut with 2 mm solid wood edge, and legs in oak or solid walnut.

### Glass.

Glass top (10 mm).

## MATERIALES







### Madera.

Sobre de tablero MDF E1 (bajo contenido en formaldehído) aplacado en madera de roble o nogal natural con canto en madera maciza de 2 mm, y patas en roble o nogal macizo.

### Vidrio.

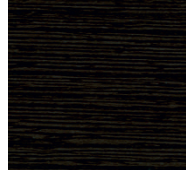
Sobre de vidrio (10 mm).

## Top & Legs. Sobre y Patas

A	C	C	C	C
				
<b>SUPER MATT OAK</b> ROBLE SÚPER MATE CHENE SUPERMATE SUPER MATT EICHE ROVERE OPACO	<b>WHITENED OAK</b> ROBLE BLANQUEADO CHENE BLANCHI EICHE WEISS ROVERE SBIANCATO	<b>WALNUT STAINED OAK</b> ROBLE TEÑIDO NOGAL CHENE TEINTÉ NOYER EICHE NUSSBAUM GEBEIZT ROYERE TINTO NOLE	<b>DARK GREY STAINED OAK</b> ROBLE TEÑIDO GRIS CHENE TEINTE GRIS DUNKELGRAU GEBEIZTE EICHE ROYERE TINTO GRIGIO SCURO	<b>EBONY STAINED OAK</b> ROBLE TEÑIDO ÉBANO CHENE TEINTÉ ÉBÔNE EICHE GEBEIZT EBENHOLZ ROVERE TINTO ÈBANO
B	D	D		
				
<b>SUPER MATT WALNUT</b> NOGAL SÚPER MATE NOYER SUPER MATE SUPERMATT WALNUSS NOCE OPACO	<b>WALNUT STAINED WALNUT</b> NOGAL TEÑIDO NOGAL NOYER TEINTÉ NOYER WALNUSS GEBEIZT WALNUSS NOCE TINTO NOCE	<b>DARK STAINED WALNUT</b> NOGAL TEÑIDO OSCURO NOYER TEINTÉ FONCÉ WALNUSS DUNKEL GEBEIZT NOCE TINTO SCURO		

## Top. Sobre



**BRONZE FUME GLASS**  
VIDRIO FUMÉ BRONCE  
VERRE FUME  
BRONZE FUME GLASS  
VETRO FUMÉ