

**FRONDA CHAIR**

design by **SAM HECHT & KIM COLIN**

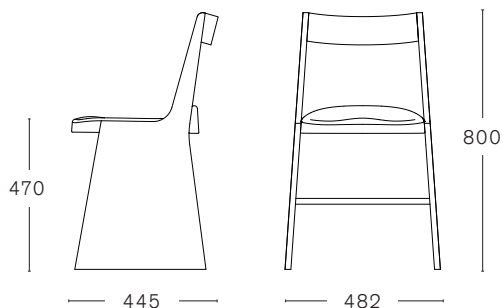

**TECHNICAL INFORMATION**

MAX. PER BOX 1 CHAIR	GROSS WEIGHT CA. kg 9,00	VOLUME 0,19 m <sup>3</sup>	BOX SIZE 520 x 490 x 840 mm
-------------------------	-----------------------------	-------------------------------	--------------------------------

**FINISHINGS**

**PINE**

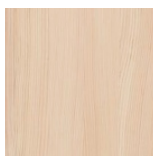

NATURAL

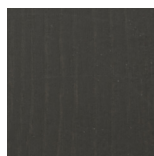

BLACK  
RAL 9005

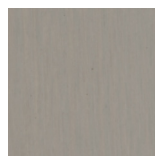

GREY  
NCS 4000

**STEEL**



BLACK  
RAL 9011



SILVER



COPPER



GREEN  
RAL 6005

**FABRIC UPHOLSTERY**

**KVADRAT PLANUM**



0111

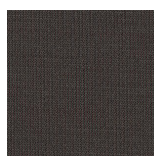

0271

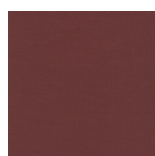

0571

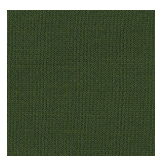

0961