

- INSTRUCTION MANUAL -

PALISSADE PARK DINING BENCH

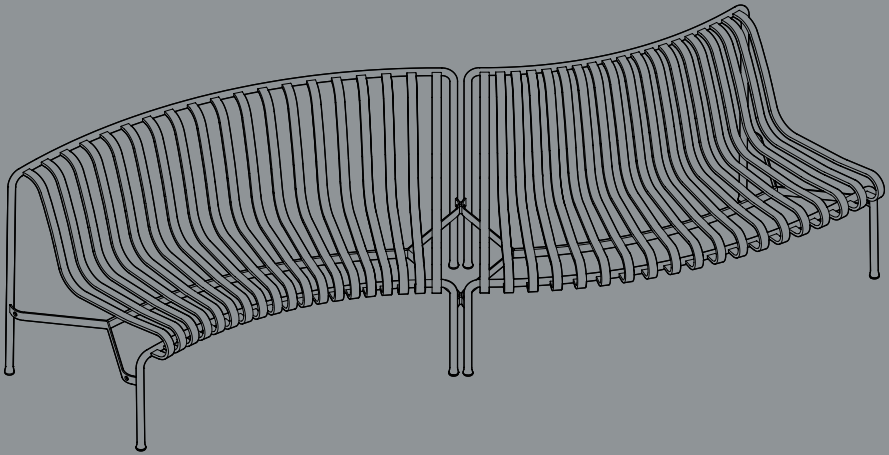

DESIGN BY RONAN & ERWAN BOUROULLEC

HAY

CAUTION

With a little care you can prolong the life of your furniture. Follow the instructions for the materials of your specific product to make sure that it stays in the best shape for as long as possible.

The information below is only intended as a general guideline. For more information on how to remove specific stains, please enquire where you bought the furniture.

- / The products in the Palissade Collection have a two component coating; a primer and an outdoor powder coating which provides a barrier to corrosive elements making it suitable for outdoor use. It complies with the highest quality standards and is designed to last, making it ideal for both private and public environments.
- / All products in the Palissade collection are handcrafted and minor blemishes and imperfections may be visible. These are not considered defects and do not interfere with the quality and function of the product.
- / Always remove stains quickly before they can do any permanent damage to the furniture.
- / Make sure to wipe off any sun cream or other liquids from the furniture after use, as these can leave stains on the surface if left in direct sunlight.
- / Wipe off the furniture if it becomes wet after rain or snowfall as this will damage the surface over time.
- / Wipe off bird droppings quickly as they may lead to permanent corrosion or staining.
- / Please be aware that the product will always be naturally affected by the surrounding environment it is exposed to, and that a certain amount of discoloration is to be expected.
- / When you move your furniture, make sure you lift it rather than pulling or pushing it to avoid damaging the floor, legs and mountings.
- / On tables and park benches, tighten up the screws after one to two months' use.
- / Avoid improper use such as sitting on the back or armrests, tilting the seats on their back legs, putting your feet on the furniture or standing on it.
- / Be careful not to scratch or damage the surface with sharp objects.
- / Avoid partially covering the surface, for example with tablecloths, cushions or place mats, as colour variances may appear.
- / Minor spots of rust under the furniture and bases are considered as a natural result of general use and can be treated using the care instructions below.
- / Direct placement on a seafront can lead to corrosion.
- / Check the status of the gliders frequently and if worn down, contact your local retailer to buy replacements. The durability of the gliders will depend on the surface the chair is placed on.

ENDCAPS

The endcaps are made of high-quality plastic (PPC). The durability of the endcap will depend on the surface that it is placed on. We recommend that you frequently check the status of the endcaps and if worn down, contact your local retailer to buy replacements.

STORAGE

The life expectancy of your furniture will vary depending on the weather and type of use. We recommend that you store it in a dry, ventilated place during winter and keep it protected from scratches and bumps.

POWDER COATED STEEL

Wipe with a clean cloth wrung in water or in a solution of water and a neutral detergent. Remove soap residue immediately using a clean, dry cloth. Avoid using scouring cream or scouring pads, as they may scratch the surface. In the event of lime deposits on the surface use a clean, damp cloth wrung in lukewarm water with one part vinegar to nine parts water and avoid scrubbing as this may scratch the surface.

Small scratches or damage to the powder coated surfaces can lead to corrosion. They can be retouched and protected from corrosion with a special repair lacquer available at HAY stores and authorized dealers. If the metal is uncovered it is necessary to sand the area before repairing it (grain 220). Wipe it over with a clean dry cloth and clean the area with methylated spirits before repainting it. Do not use solvents as they may have an adverse effect on the coating. Never use acetic acid or citric acid.

- PARTS -

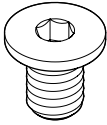

A Screw x2

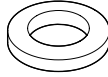

B Washer x2

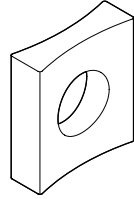

C Washer x2

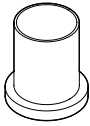

D Tubular washer x2

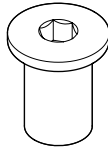

E Tubular screw x2



F Allen key x2

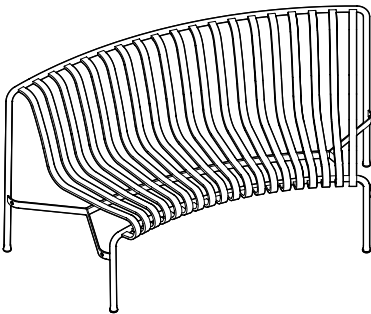

G Bench — In

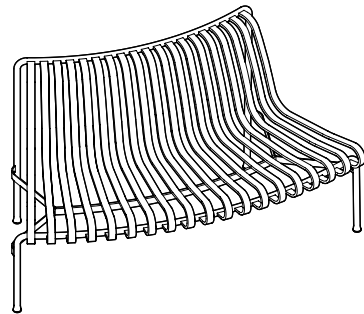

H Bench — Out



NOTICE

Never use single benches.
Always connect two benches or more.

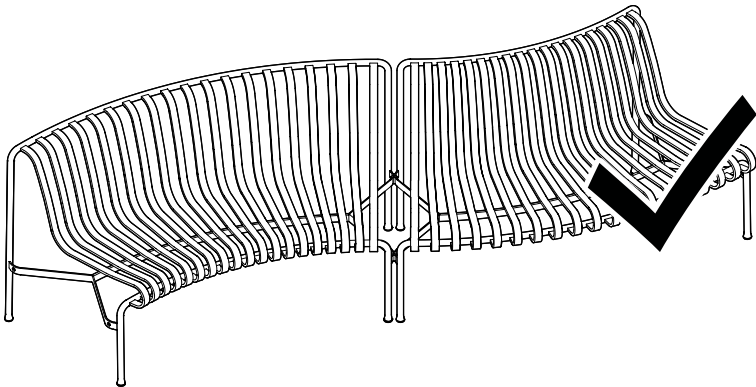
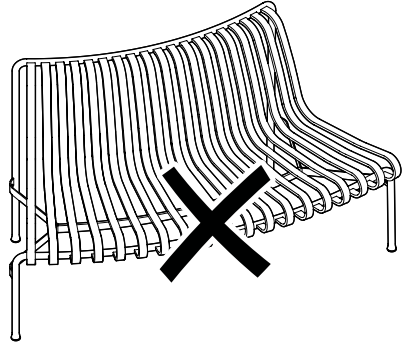
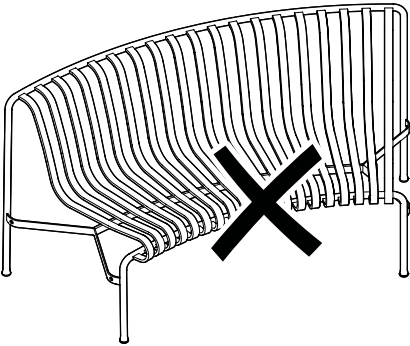

1.

Connect the back legs of the benches as illustrated.
Use the Allen key **F** to lightly tighten the screws from both ends.

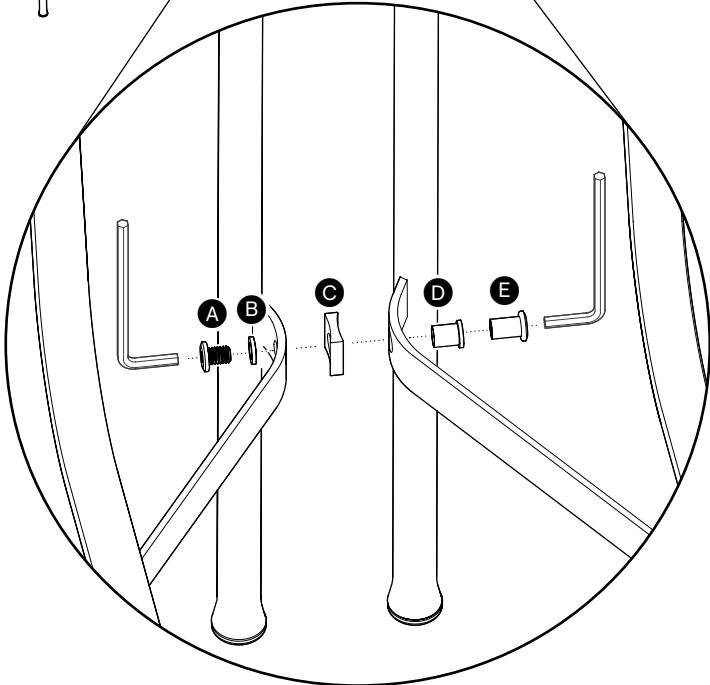
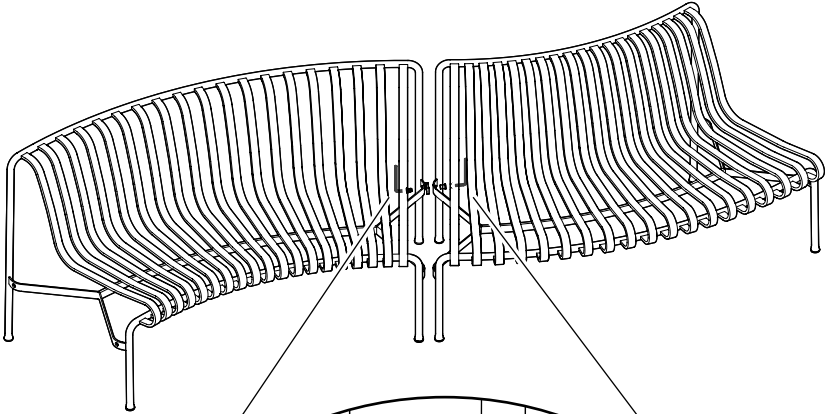

2.

We recommend using two people to connect the front legs - one person to pull and push the legs until the holes are aligned, and another to insert the hardware (as shown in step one), and tighten all the screws completely.

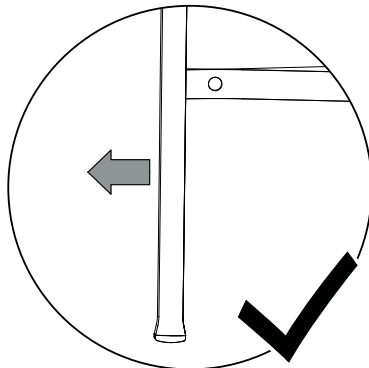
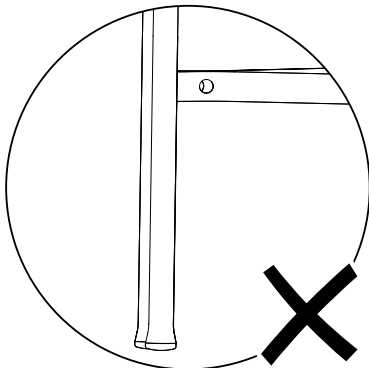
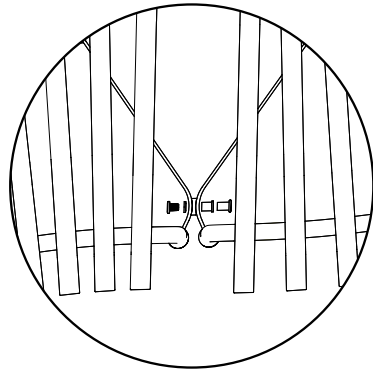
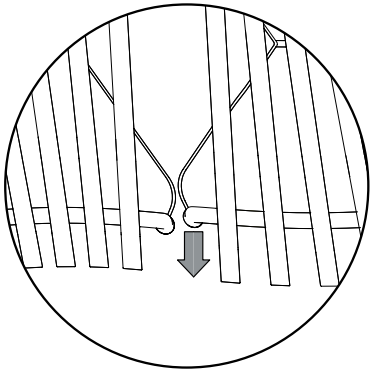
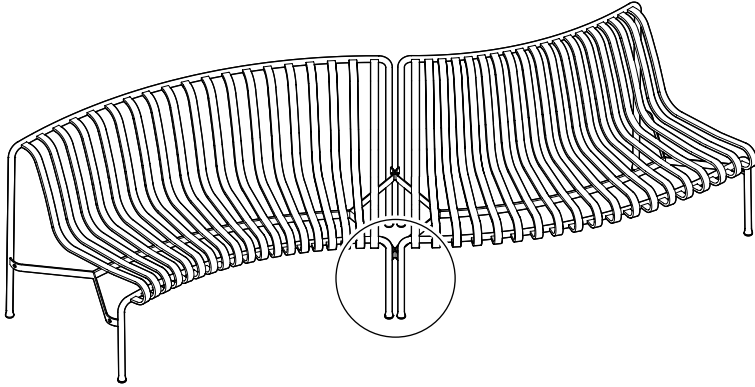

- CARE & MAINTENANCE -

Our Care & Maintenance offers guidance for optimal maintenance of your HAY product. It includes advice and instructions on cleaning and caring for specific materials to prolong the life of your furniture.



Please find our Care & Maintenance guide by scanning the QR code



You can find more relevant information on Palissade Park Dining Bench by scanning the QR code

You can also find the same information here hay.dk/downloads

Havnen 1 8700 Horsens Denmark
+45 4282 0282 / hay@hay.com

13/12/2021

HAY