



N.811

TECHNISCHES BLATT  
SCHEDA TECNICA  
DATA SHEET  
FICHE TECHNIQUE

# N.811

DESIGN JOSEF HOFFMANN, 1930



Stuhl mit oder ohne Armlehnen aus Buchenbugholz. Erhältlich in 3 Versionen: Sitz und Rückenlehne aus Wiener Geflecht, gepolsterter Sitz und Rückenlehne aus Wiener Geflecht, gepolsterter Sitz und Rückenlehne.

Sedia e poltroncina in faggio curvato. Disponibili in 3 versioni: seduta e schienale in paglia di Vienna, seduta imbottita e schienale in paglia di Vienna, seduta e schienale imbottiti.

Bent beech-wood chair and armchair. Available in 3 versions: woven cane seat and backrest, upholstered seat and woven cane backrest, upholstered seat and backrest.

Chaise et petit fauteuil en hêtre cintré. Disponibles en 3 versions: assise et dossier en paille de Vienne, assise rembourrée et dossier en paille de Vienne, assise et dossier rembourrés.

Silla y butaca en haya curvada. Disponible en 3 versiones: asiento y respaldo en paja de Viena, asiento tapizado y respaldo en paja de Viena, y asiento y respaldo tapizados.



**SD0811PGL**

Dimensions mm.  
height 820 | width 450 | depth 480



**SD0811TES**

Dimensions mm.  
height 820 | width 450 | depth 480



**SD0811TE2**

Dimensions mm.  
height 820 | width 450 | depth 480



**PT0811PGL**

Dimensions mm.  
height 820 | width 510 | depth 510



**PT0811TES**

Dimensions mm.  
height 820 | width 510 | depth 510



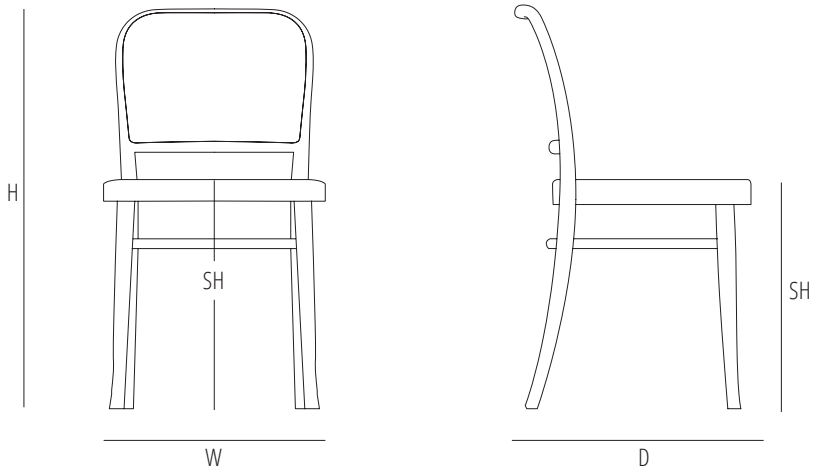

**PT0811TE2**

Dimensions mm.  
height 820 | width 510 | depth 510



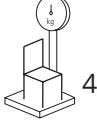
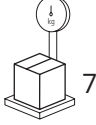
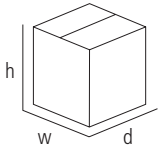

	H	W	D	SH	AH
mm	820	450	480	490	
inch	32,2	17,7	18,8	19,2	

 1
  max. 2
  0,36
  4
  7
 

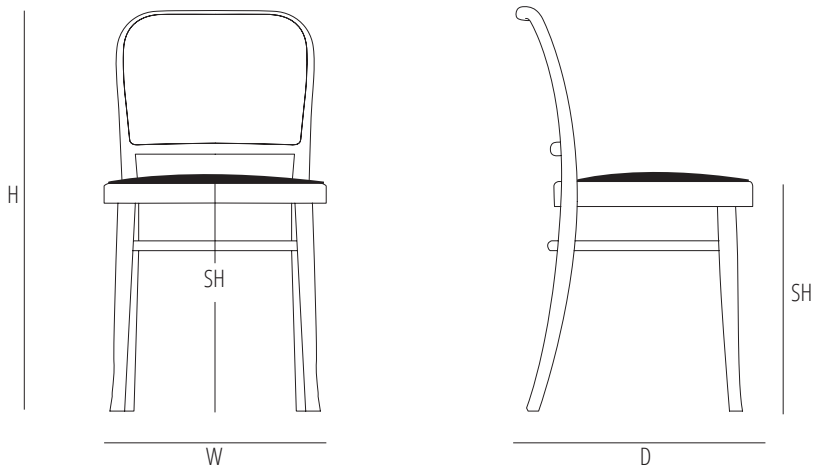
mm - inch  
 h 960 - 37,7  
 w 620 - 24,4  
 d 600 - 23,6

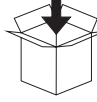

	H	W	D	SH	AH
mm	820	450	480	490	1 Pz/Pc: 50 cm. Linear x 140 cm h/width
inch	32,2	17,7	18,8	19,2	2 Pz/Pc: 50 cm. Linear x 140 cm h/width

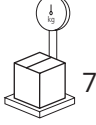
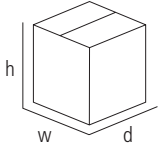
 1
  max. 2
  0,36
  4
  7
 

mm - inch  
 h 960 - 37,7  
 w 620 - 24,4  
 d 600 - 23,6

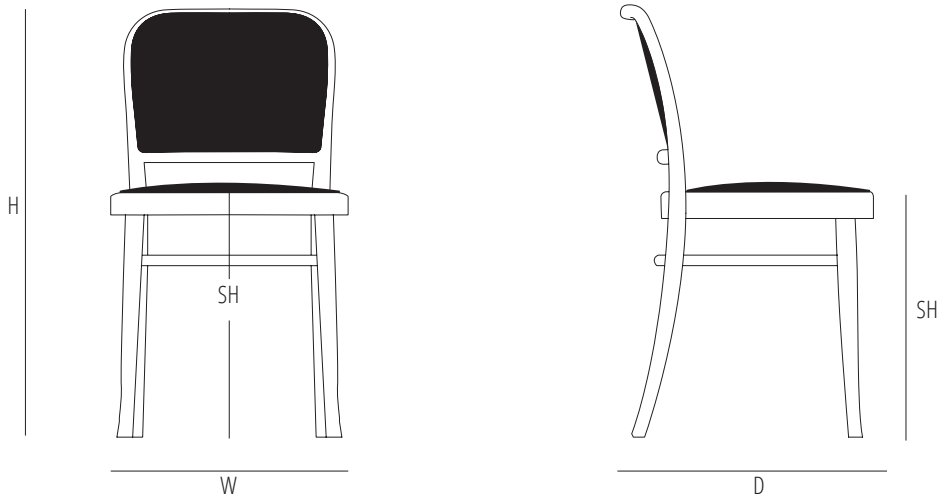

	H	W	D	SH	AH
mm	820	450	480	490	1 Pz/Pc: 100 cm. Linear x 140 cm h/width
inch	32,2	17,7	18,8	19,2	2 Pz/Pc: 200 cm. Linear x 140 cm h/width

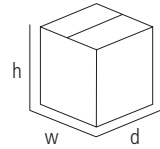
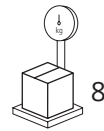
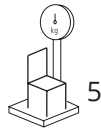
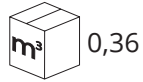

mm - inch  
 h 960 - 37,7  
 w 620 - 24,4  
 d 600 - 23,6

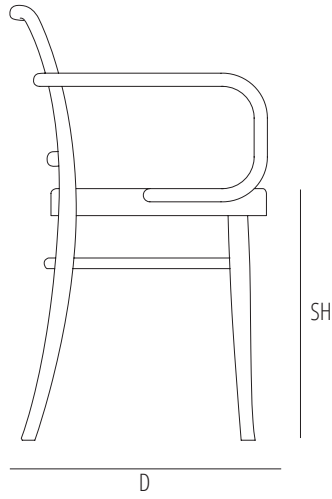
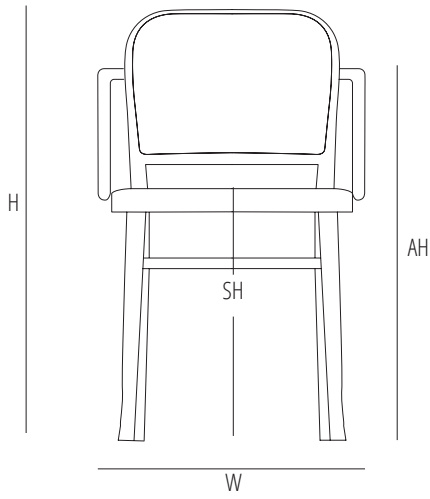

	H	W	D	SH	AH
mm	820	510	510	490	700
inch	32,2	20	20	19,2	27,5

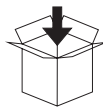
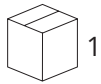

max. 1

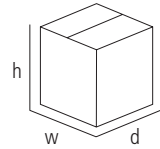
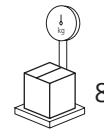
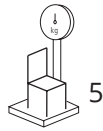
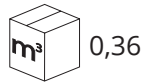

mm - inch  
h 960 - 37,7  
w 620 - 24,4  
d 600 - 23,6

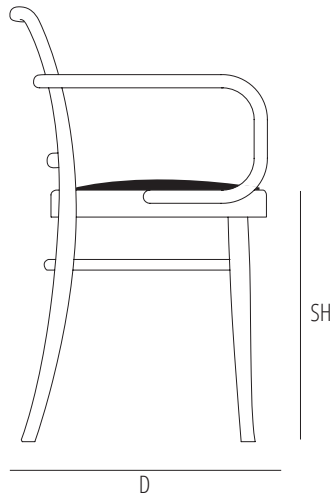
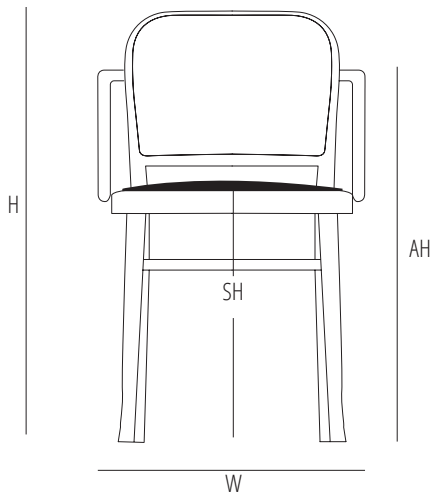

	H	W	D	SH	AH
mm	820	510	510	490	700
inch	32,2	20	20	19,2	27,5

1 Pz/Pc: 50 cm. Linear x 140 cm h/width  
2 Pz/Pc: 50 cm. Linear x 140 cm h/width

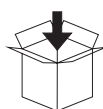
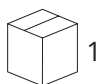

max. 1

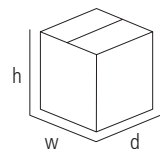
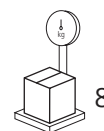
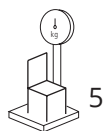
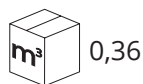

mm - inch  
h 960 - 37,7  
w 620 - 24,4  
d 600 - 23,6

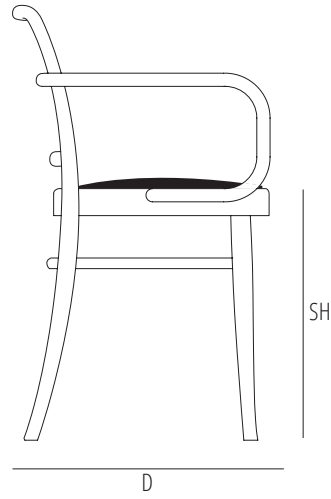
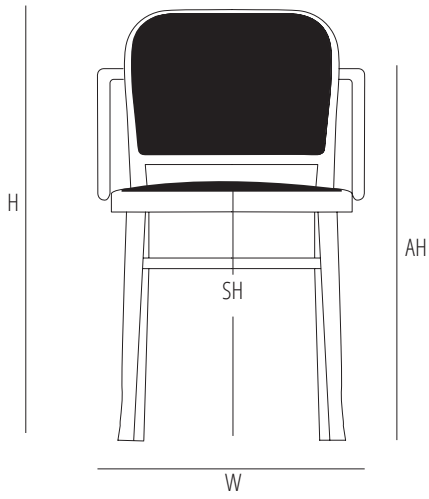

	H	W	D	SH	AH	
mm	820	510	510	490	700	1 Pz/Pc: 100 cm. Linear x 140 cm h/width
inch	32,2	20	20	19,2	27,5	2 Pz/Pc: 200 cm. Linear x 140 cm h/width

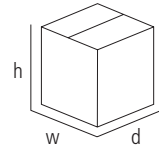
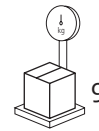
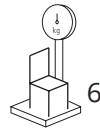
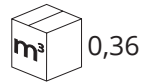

mm - inch  
 h 960 - 37,7  
 w 620 - 24,4  
 d 600 - 23,6

Verfuegbare Ausfuehrungen  
Finiture disponibili  
Available finishes  
Finitions disponibles

SOLID WOOD / ESSENZE NATURALI



B01 BEECH  
B01 FAGGIO

STAINS / TINTI



B03 DARK WALNUT  
B03 NOCE SCURO



B04 WENGÈ  
B04 WENGÈ



B08 BEECH-WOOD STAINED IN NOCE CANALETTO  
B08 FAGGIO TINTO NOCE CANALETTO

CLASSIC LACQUER / LACCATO CLASSICO



C01 - RAL 9005 BLACK

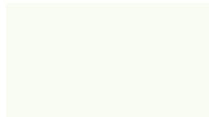

C02 - RAL 9010 PURE WHITE

CONTEMPORARY LACQUER / LACCATO CONTEMPORANEO



D01 - RAL 1013 PEARL WHITE



D02 - RAL 7047 TELEGREY 4



D03 - RAL 7030 STONE GREY



D19 - S7502 G DARK GREY



D21 - S1510 Y80R POWDER PINK



D29 - S3060 Y60R RED ORANGE



D26 - S3560 Y80R CARMINE RED



D14 - RAL 3005 WINE RED



D30 - S3030 B PASTEL BLUE



D11 - RAL 7000 SQUIRREL GREY



D12 - RAL 7031 BLUE GREY



D25 - RAL 5011 STEEL BLUE



D15 - RAL 5020 OCEAN BLUE



D27 - S1050 Y10R MELON YELLOW



D28 - S2050 G90Y CAMPUS GREEN



D23 - S6020 G10Y DARK GREEN

Gebrüder Thonet Vienna GmbH  
Prinz Eugen Straße 42  
1040 Wien (AT)

**[www.gebruederthonetvienna.com](http://www.gebruederthonetvienna.com)**

Offices of the trademarks' licensee  
Production Furniture International S.p.A.  
Via Foggia, 23/H  
10152 Torino (TO) Italy

Phone: 0039 011 0133330 - [info@gebruederthonetvienna.com](mailto:info@gebruederthonetvienna.com)